

**Biomass Estimation by Hydro-acoustic Methods in the South China Sea,  
Area II : Sarawak, Sabah and Brunei Darussalam.**

**Yuttana Theparoonrat**

Training Department, Southeast Asian Fisheries Development Center.

**ABSTRACT**

The abundance of fisheries resources and their structure off shore of Sarawak, Sabah and Brunei Darussalam were investigated under the SEAFDEC Collaborative Research Survey. Hydro-acoustic surveying by using a scientific echo sounder model FQ-70 was conducted for estimating the fish abundance and biomass. Two survey cruises were carried out by M.V. SEAFDEC during 10 July to 2 August 1996 and 1 to 24 May 1997 for pre and post-northeast monsoon seasons, respectively. The scientific echo-sounder was equipped with an echo-integrator and two quasi-ideal beam transducers with operating frequencies of 50 and 200 kHz. For pre and post-northeast monsoon season was 1,717,852 tons and 956,397 tons, respectively. The maximum fish abundance were found at the water depth between 100 to 200 m was 92.4% and 49.8% of total abundance for pre and post-northeast monsoon season, respectively.

Key words: Biomass estimation, Acoustic survey, South China Sea, Sarawak, Sabah, Brunei Darussalam.

**Introduction**

Marine fisheries resources are migrate according to the change of seasonal and maturity state. The abundance estimation of such migratory species are need to design the survey with cover all that particular area. Southeast Asian Fisheries Development Center (SEAFDEC) was proposed to conduct the Collaborative Research Survey on the marine fisheries resources and the environmental factors in the South China Sea of SEAFDEC member country's waters. Two survey cruise were performed by M.V. SEAFDEC during pre-northeast monsoon season from 10 July to 2 August 1996 and post-northeast monsoon season from 1 to 24 May 1997. The objective of the survey is to estimate the abundance of fisheries resources and their structures at the off shore of Sarawak, Sabah and Brunei Darussalam waters, and to study on the variation of the abundance during pre-northeast monsoon and post-northeast monsoon season.

**Materials and Methods**

The survey area was divided into 79 oceanographic survey stations (Fig 1). Each station were located at 30 nautical miles apart. The hydro-acoustic survey by using scientific echo-sounder model FQ-70 are carried out along the parallel cruise track of 30 nautical mile. Scientific echo-sounder was equipped with dual frequency by using two quasi-ideal beam transducers with operated on 50 kHz and 200 kHz. This acoustic survey system were equipped with echo integrator, calibration system and data recorder. The system is designed so that a vast amount of data can be stored onto the floppy disk memory and processed by the data analyzer. The raw data from Furuno FQ-70 software in form of K3 ASCII code are using for the calculation. The volume back scattering strength (SV) of high frequency (200 kHz) was calculated from data recorded from 10 to 200 m.

The calibration of FQ-70 is conducted before the survey cruise is performed at the survey station number 1. M.V. SEAFDEC is anchored at the water depth of 36 meter where the clam sea and weak current of 0.4 knot. The calibration is performed by using standard hydrophone model TW-9103-S attached at 1 meter under the transducer sound beam axis. Both low (50 kHz) and high fre-

quency (200 Attenuation and Gain, Transmitting Sensitivity of Transducer, and Receiving Sensitivity of Transducer.

### Hydro-acoustic Data Collection

The hydro-acoustic data of fish school in the area of Sarawak, Sabah and Brunei Darussalam are recorded by using scientific echo sounder (FQ-70). The data of means volume back scattering was recorded by high frequency (200 kHz.) with the transmission rate of 123 ping/min. The ship constant cruising speed is 10 knots. During the survey cruise, the raw data of reflected echo signal from fish school also recorded on to VHS Video tape for data bank reservation. The processed echo information from echo integrator with the distance interval of 0.1 nautical mile were calculated by echo integrator and data analyzer. The integration of volume back scattering strength (SV) of fish school were calculated from the water depth layer of 10 m to 200 m for 8 integration layers. Two bottom integration layers were calculated at 1 m to 5 m to 10 m above the sea bottom. The integrated of SV and density of fish were recorded on the floppy disk as well as printed out on printer and also plotted on the echogram. The recorded data was recalculation for biomass estimation of fisheries resources and their distribution in the survey area. The parameters setting for echo integrator unit are showing below:

<u>The Parameter Setting for Echo Integrator Unit</u>				
<b>Range</b>			<b>Sonar parameter</b>	
1. REC RANGE		0 - 200 m	1. Calculation	SV-H SV-L
2. LAYER	1	10 - 20 m	2. SL	220.00 215.10
	2	20 - 40 m	3. ME	-194.90 -185.60
	3	40 - 60 m	4. Absorption	92.70 9.90
	4	60 - 80 m	5. 10 log y	-16.10 -14.50
	5	80 - 100 m	6. AMP Gain	50.30 49.00
	6	100 - 130 m	7. Pulse Length	1.20 1.20
	7	130 - 160 m	8. Sound Velocity	1500.00
	8	160 - 200 m		
	9	B10 -B5 m		
	10	B5 - B1 m		

### Calculation of Volume Back Scattering Strength (SV)

The volume back scattering strength (SV) of fish school is obtained from the following equation;

$$SV = 20 \log V_{sv} - (SL + ME) + 20 \log r + (2\alpha r/1000) - 10 \log (\log (c\tau/2)) - 10 \log \psi$$

where

SV	:	Volume Back scattering Strength, (dB)	$\alpha$	:	Absorption Coefficient (dB/km)
Vsv	:	Voltage output (Vrms)	$c$	:	Underwater Sound speed (m/sec)
SL	:	Source Level, (dB)	$\tau$	:	Pulse duration (ms)
ME	:	Receiving Sensitivity, (dB)	$\psi$	:	Equivalent beam width

r : Range of target (m)

The scientific echo sounder FQ-70 can be automatically calculated the means volume back scattering strength ( $SV_{avg}$ ) in particular layer width and log interval of ship cruising. The calculation can be perform with pre-setting parameter by the following equation;

$$SV_{avg} = (\sum \Delta_r \sum_1 sv_i) / \Delta r l$$

where  $\Delta_r$  : Layer width  
 l : Log interval

During the survey cruise, the layer width and log interval was set at 0.1 nautical mile. The fish density can be calculated as the following formula;

$$N = 10^{(SV-BSV)/10}$$

where N : Density of fish in the integrating layer ( $n/m^3$ )  
 BSV : Back scattering strength of a single fish per unit volume (=TS)

The calculation of SV was performed by average the SV from 1<sup>st</sup> layer with started at 10 m depth down to 200 m layer. The layer at with sea bottom appear was excluded from the calculation but will be substituted by two bottom layer of layer 9 and 10

***Averaging the SV Value in Sections of the Distance Run***

The average of SV value in section of distance run can be calculated by using the following equation :

$$SV_{avg} : = 10 \log \left( \frac{\sum 10^{(sv_i/10)}}{K} \right)$$

where  $SV_{avg}$  : SV value after averaging  
 $Sv_i$  : SV value of each section  
 K : Number of integral per section of distance run

The integrated average SV from FQ-70 were check and eliminated the high SV value caused by the interference from the ship electronic equipment

**Biomass estimation**

Biomass is defined as the density of fish (Tones per square nautical mile) in the area surveyed, derived from the integrated echoes. The biomass estimation can be perform by using Algebraic Method (Johannesson and Mitson, 1983). The basic principle is schematically illustrated in Fig. 2. Each sample observation ( $a_i$ ) is assigned to a corresponding rectangular area, here call “Elementary Statistical Sampling Rectangle” (ESSR). For a parallel survey grid with equidistant inter-transect spacing (Dt) (30 nautical mile) all ESSR’s will have equal area sizes given by

$$ESSR = Dt \times (ESDU) \text{ mile}^2$$

where ESDU is the selected “Elementary Sampling Distance Unit”. When the inter-transect spacing equal one ESDU, it follow that the ESSR becomes a square of size  $(ESDU)^2$

The estimation of biomass was calculated by using algebraic Method with estimated the means SV of each Elementary Statistical Sampling Interval (ESSR) with cover area is 30x30 nautical miles. The population density (fish/m<sup>2</sup>) was calculated by using the parameter of means SV in each ESSR and fish target strength (TS). The average TS of fish was calculated by the equation (Miyanoohana et al, 1987; Furusawa, 1990 as following ;

$$TS = 20 \log l - 66 \text{ (dB)}$$

Where  $l$  is fish length in cm.

Since, the maximum catch of pelagic species in Sarawak, Sabah and Labuan of Malaysia contributed from sardine with annual catch ranging from 16,907 tons to 19,958 tons from 1994 to 1995 (Table.1 (D.O.F. Malaysia, 1994, 1995, 1996), then sardine was selected as the representative species for determine TS of single fish for biomass estimation. The target strength (TS) of sardine (*Sardinella gibbosa*) with the first capture at body length of 10 cm and weight of 10 gm (Somjaiwong, 1991) is – 46.0 dB was using for the calculation. The abundance of biomass in each ESSR in obtained by multiplying the population density in the ESSR to the means weight of sardine.

Table 1 Landing of marine fish by year and species of Sarawak, Sabah and Labuan.

<b>Fish Species</b>	<b>1993</b>	<b>1994</b>	<b>1995</b>
Round Scad	11,650	13,779	15,833
Sadine	7,802	16,907	19,958
Tuna	20,028	14,548	18,050
Mackerel	18,249	15,106	13,092
Spanish Mackerel	12,077	6,871	8,393
<b>Total</b>	<b>69,806</b>	<b>67,211</b>	<b>75,326</b>

## Result and Discussion

Fig 3 shows the echogram of pelagic and demersal fish school detected by 200 kHz. And 50 kHz. The echogram also showing the vertical distribution curve (VDC) with scale ranging from –80 dB to –30 dB. The VDC detected by 50 kHz Shows the high reverberation level from surface to bottom. Where as VDC detected by 200 kHz. Showing the less values. The sample of average volume back scattering strength (SV) and density of fish (N) in each depth layer with integrated for each 0.1 nautical mile of 200 kHz And 50 kHz.

Fig. 4 and Fig. 5 showed the biomass distribution presented by means SV at each 0.1 nautical mile measured during pre and post-northeast monsoon season, respectively. The SV showing high value of both season at the shallow water and around the station numbers 25, 26, 27, 36, 41, 42 and 50 where, the stations are between the contour line of 100 m to 200 m. During the survey cruise, the echogram can be recorded a lot of big pelagic fish school.

The summary of biomass estimation by frequency of 200 kHz. During pre-northeast monsoon and post-northeast monsoon season are showing in Table 2 and 3. The total estimated biomass during pre-northeast monsoon season are 1,717,852.38 tons and 956,396.88 tons, respectively. The biomass distribution are showing in Fig. 6 and 7 for pre and post-northeast monsoon season, respectively.

During the post-northeast monsoon season, the maximum biomass is presented between station number 50 to 51 with the water depth of 160 m. in the amount of 1,384,550.00 tons. The minimum biomass is presented between station number 63 to 64 in the amount of 93.06 tons Where the water depth is 1600 m. The total biomass presented at the water depth of <100m, 100 to 200m and

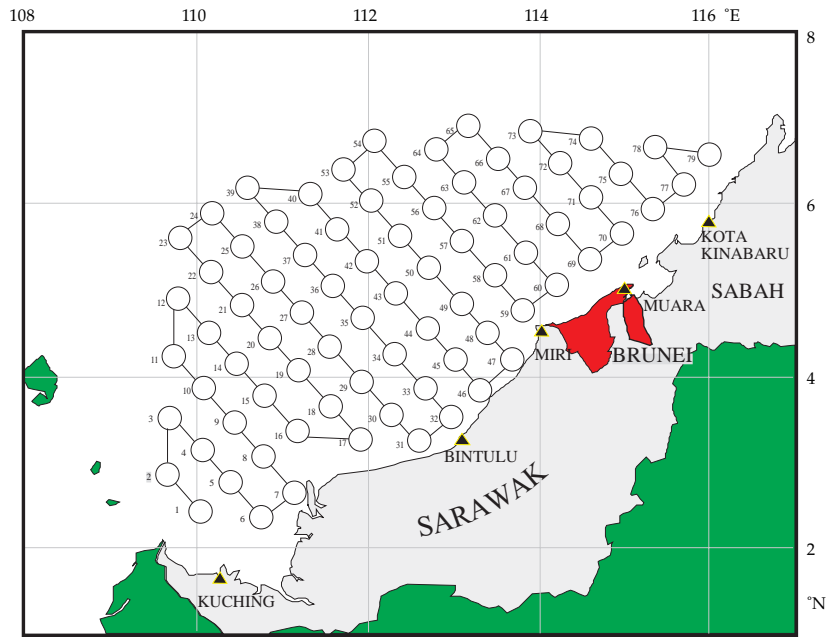

Fig. 1 The survey area

Fig. 2. Elementary statistical sampling interval (ESSR) along the cruise track when the inter-transect ( $Dt$ ) equals one elementary sampling distance unit (ESDU). Total biomass estimation is the summation of all the abundance of the ESSR area.

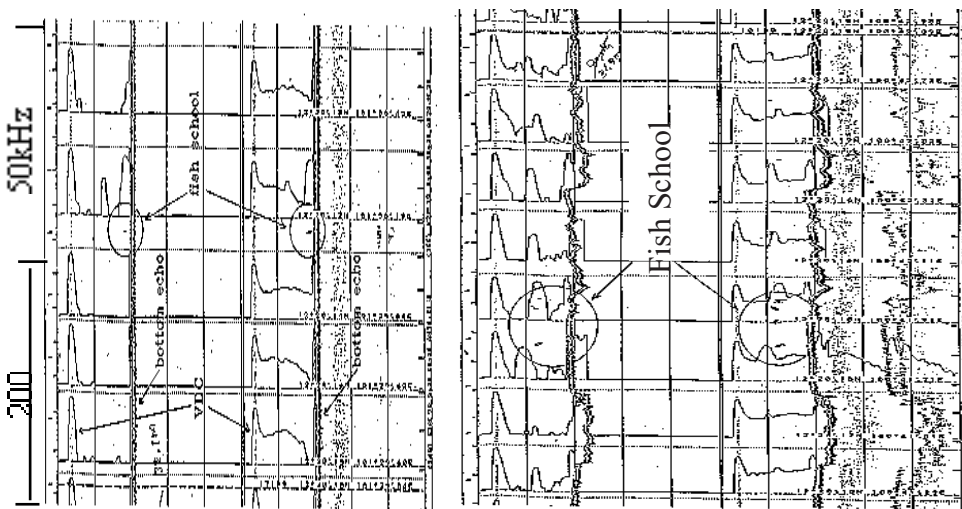
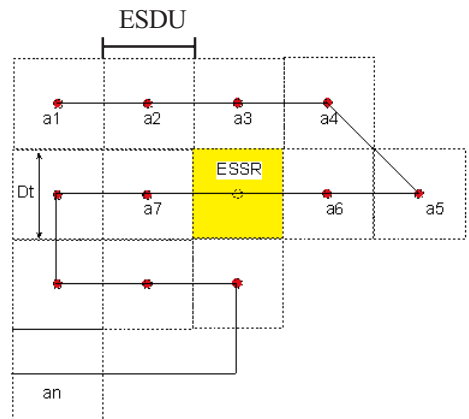

Fig. 3 The echogram of pelagic and demersal fish schools superimposed with Vertical Distribution Curve (VDC) detected by 50 kHz. and 200 kHz.

Table 2 Summary of biomass estimation by high frequency (200kHz) during premonsoon season off shore Sarawak, Sabah and Brunei Darussalam. The table show estimation for each station (ESSR) with cover area is 30x30 nautical mile

Station	Means SV (dB)	Weight (tons)	Depth (m)	Station	Means SV (dB)	Weight (tons)	Depth (m)
1-2	-72.87	2953.02	46.5	40-41	-90.47	220.47	200.0
2-3	-82.83	424.48	66.2	41-42	-68.77	29489.90	180.6
3-4	-84.37	322.92	71.9	42-43	-68.54	20559.98	119.5
4-5	-76.97	1730.17	70.1	43-44	-76.13	2845.26	95.0
5-6	-74.45	1715.50	38.9	44-45	-83.41	429.57	76.7
6-7	-71.83	2906.67	36.0	45-46	-75.92	1383.76	44.0
7-8	-68.52	5892.31	34.1	46-47	-64.81	10314.61	25.4
8-9	-74.26	2305.88	50.0	47-48	-72.19	4179.90	56.3
9-10	-85.74	260.51	79.5	48-49	-79.40	1314.43	93.2
10-11	-88.88	152.36	95.7	49-50	-72.03	10834.45	140.7
11-12	-68.60	18238.01	107.6	50-51	-51.55	1384550.00	160.9
12-13	-86.25	328.15	112.7	51-52	-86.56	542.54	199.9
13-14	-87.82	204.31	100.6	52-53	-85.01	775.07	200.0
14-15	-82.52	548.99	79.8	53-54	-81.55	1719.86	200.0
15-16	-72.96	3542.96	57.0	54-55	-87.06	484.22	200.0
16-17	-66.01	12012.21	39.0	55-56	-84.98	780.03	200.0
17-18	-71.11	3734.24	39.2	56-57	-93.03	122.22	200.0
18-19	-76.06	1846.91	60.6	57-58	-79.87	2531.68	200.0
19-20	-78.41	1433.26	80.8	58-59	-82.76	1206.11	185.2
20-21	-76.10	3087.13	102.2	59-60	-77.14	4087.36	172.1
21-22	-74.13	6201.32	130.7	60-61	-92.49	138.60	200.0
22-23	-77.60	3106.12	145.4	61-62	-90.41	223.86	200.0
23-24	-77.15	4128.30	174.4	62-63	-81.88	1594.94	200.0
24-25	-82.68	1325.05	200.0	63-64	-94.22	93.06	200.0
25-26	-70.05	18492.92	152.3	64-65	-84.43	886.63	200.0
26-27	-69.11	16483.74	109.4	65-66	-86.44	557.56	200.0
27-28	-67.22	20153.80	86.4	66-67	-78.45	3510.98	200.0
28-29	-76.94	1662.97	66.8	67-68	-90.78	205.45	200.0
29-30	-71.24	4104.37	44.5	68-69	-82.11	1373.12	181.8
30-31	-70.79	2680.09	26.1	69-70	-76.52	2852.94	104.3
31-32	-65.88	9762.12	30.7	70-71	-70.21	23020.09	196.7
32-33	-74.45	1937.49	43.9	71-72	-85.60	677.37	200.0
33-34	-80.59	643.74	60.0	72-73	-81.09	1913.19	200.0
34-35	-80.45	873.43	78.8	73-74	-87.01	489.67	200.0
35-36	-78.06	1882.09	98.0	74-75	-80.63	2126.18	200.0
36-37	-70.29	15615.09	135.7	75-76	-75.11	7235.07	191.0
37-38	-82.76	1300.35	200.0	76-77	-73.94	4985.01	100.5
38-39	-88.99	310.04	200.0	77-78	-80.05	2202.20	181.2
39-40	-80.24	2324.37	200.0	78-79	-74.02	8767.69	180.0
<b>Total =</b>						<b>1717852</b>	

Table 3. Summary of biomass estimation by high frequency (200 kHz) during post-northeast monsoon season off shore of Sarawak, Sabah and Brunei Darussalam. The table show estimation for each station (ESSR) with cover area is 30 x 30 nautical mile.

Station	Means SV (dB)	Weight (tons)	Depth (m)	Station	Means SV (dB)	Weight (tons)	Depth (m)
1-2	-62.73	30475.03	46.5	40-41	-73.28	11544.31	199.9
2-3	-73.22	3901.30	66.6	41-42	-70.87	18149.18	180.5
3-4	-71.76	5959.60	72.8	42-43	-68.17	22378.88	119.4
4-5	-68.99	10906.12	70.3	43-44	-74.53	4107.04	94.9
5-6	-69.81	4966.83	38.6	44-45	-74.11	3672.33	76.9
6-7	-67.90	7283.08	36.5	45-46	-65.60	15003.80	44.3
7-8	-72.96	2165.15	34.7	46-47	-63.93	12804.26	25.7
8-9	-68.89	8018.83	50.5	47-48	-65.69	18732.57	56.4
9-10	-80.16	937.97	79.1	48-49	-75.17	3499.58	93.5
10-11	-77.95	1895.55	96.1	49-50	-68.02	27524.18	142.1
11-12	-65.37	38629.55	108.1	50-51	-69.68	21489.75	162.4
12-13	-74.30	5163.92	113.1	51-52	-69.93	25005.21	200.0
13-14	-76.81	2548.95	99.5	52-53	-76.69	5271.18	200.0
14-15	-72.81	5170.71	80.2	53-54	-68.85	32017.28	200.0
15-16	-74.39	2563.12	57.2	54-55	-80.44	2220.10	200.0
16-17	-62.22	29410.04	39.9	55-56	-82.99	1235.54	200.0
17-18	-68.77	6329.70	38.7	56-57	-75.35	7175.69	200.0
18-19	-69.57	8302.24	61.2	57-58	-71.03	19359.08	200.0
19-20	-75.64	2742.49	81.7	58-59	-71.71	15065.28	181.6
20-21	-74.41	4566.07	102.5	59-60	-66.50	44562.34	162.0
21-22	-74.64	5474.31	129.7	60-61	-82.39	1418.77	200.0
22-23	-67.81	29603.82	145.4	61-62	-71.05	19278.31	200.0
23-24	-76.23	5012.40	171.3	62-63	-78.92	3150.28	200.0
24-25	-72.20	14823.12	199.9	63-64	-83.83	1016.37	200.0
25-26	-68.33	27626.06	152.9	64-65	-89.80	256.87	200.0
26-27	-81.99	850.65	109.5	65-66	-77.60	4274.07	200.0
27-28	-73.48	4784.12	86.8	66-67	-75.46	6992.36	200.0
28-29	-69.23	9861.52	67.2	67-68	-78.56	3421.60	200.0
29-30	-70.61	4755.88	44.5	68-69	-68.36	32650.16	181.9
30-31	-61.99	23392.87	26.1	69-70	-69.69	13898.91	105.4
31-32	-58.10	58311.63	30.7	70-71	-77.63	4185.10	197.5
32-33	-65.59	14907.20	43.9	71-72	-80.30	2295.99	200.0
33-34	-75.17	2253.92	60.2	72-73	-73.85	10120.98	200.0
34-35	-83.11	474.30	78.9	73-74	-78.49	3482.21	200.0
35-36	-78.10	1864.24	97.8	74-75	-85.13	753.75	200.0
36-37	-62.34	95461.97	133.1	75-76	-83.43	1066.63	191.3
37-38	-75.60	6768.21	200.0	76-77	-76.45	2744.86	98.7
38-39	-80.05	2427.10	200.0	77-78	-68.00	35457.60	182.0
39-40	-75.30	7258.02	200.0	78-79	-82.41	1266.92	179.7
<b>Total =</b>						<b>956397</b>	

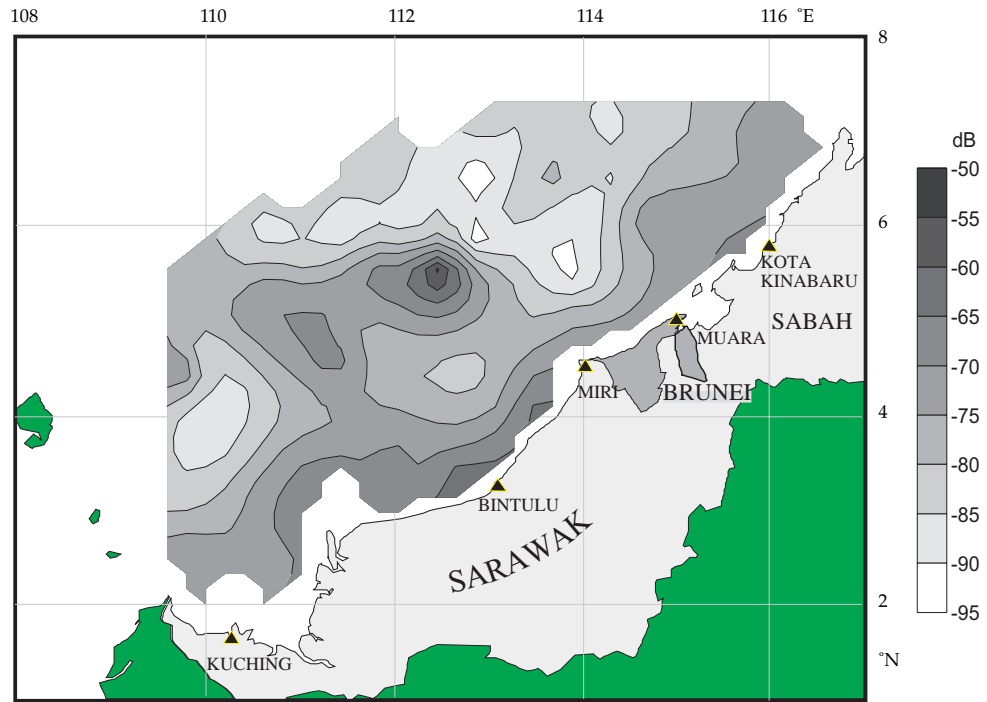

Fig. 4 Distribution of back scattering volume (SV) of fish biomass measured during the pre monsoon season in Sarawak , Sabah and Brunei Darussalam waters.

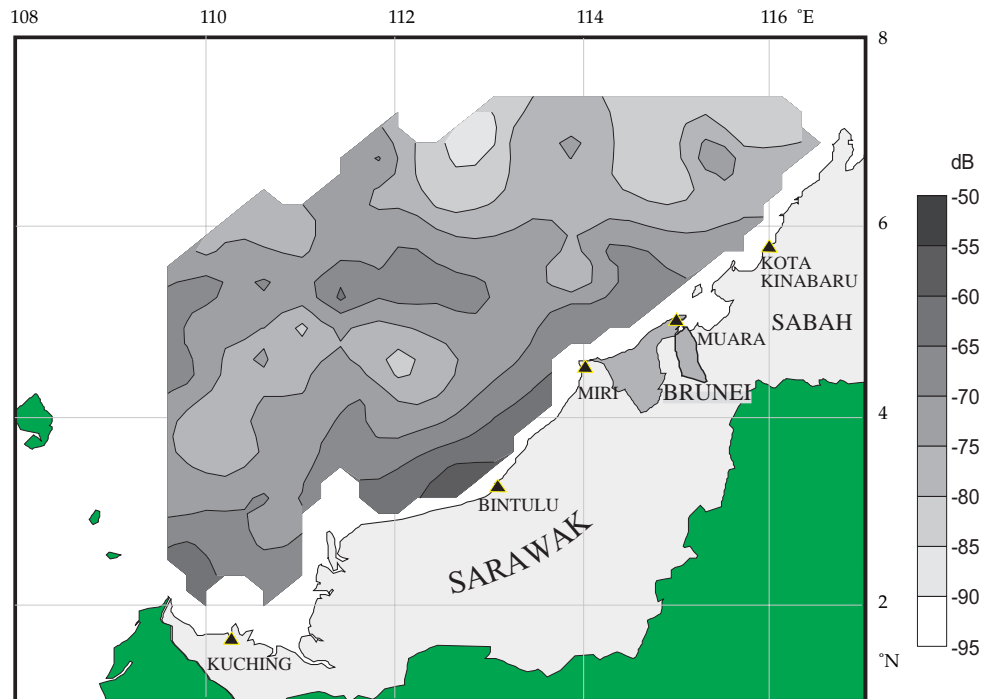

Fig. 5 Distribution of back scattering volume (SV) of fish biomass measured during the post monsoon season in Sarawak , Sabah and Brunei Darussalam waters.



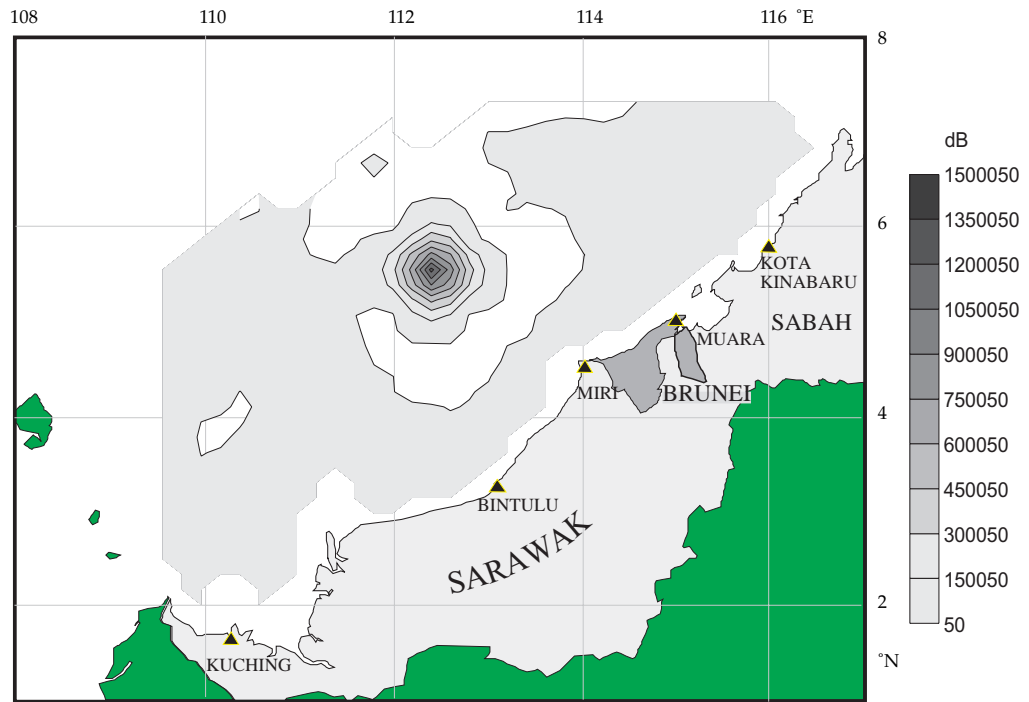

Fig. 6 Distribution of average fish biomass (ton x 900nm) during the pre monsoon season in Sarawak , Sabah and Brunei Darussalam waters.

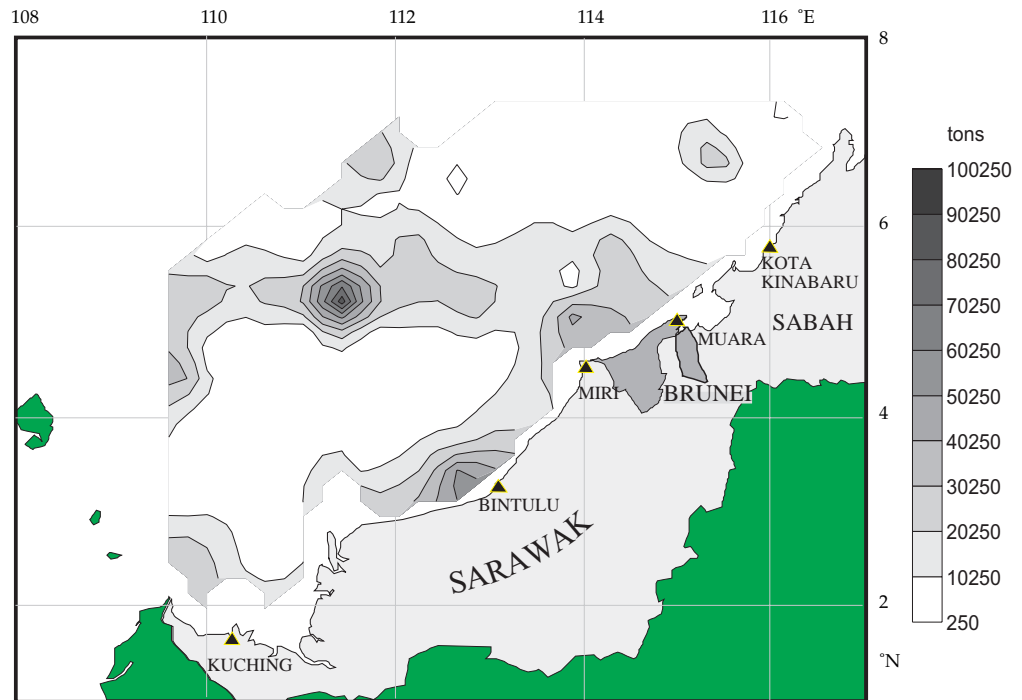

Fig. 7 Distribution of average fish biomass (ton x 900nm) during the post monsoon season in Sarawak , Sabah and Brunei Darussalam waters.